

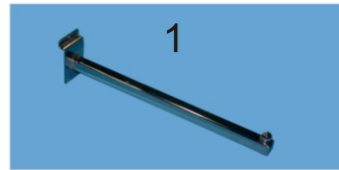

GRILL ACCESSORIES



1



2

SM207BG-7BALL ARM

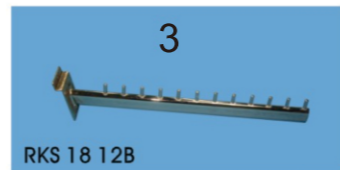

3

RKS 18 12B

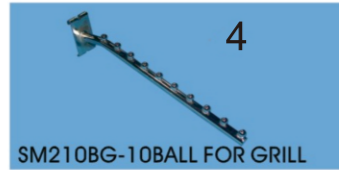

4

SM210BG-10BALL FOR GRILL

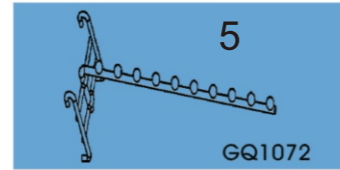

5

GQ1072

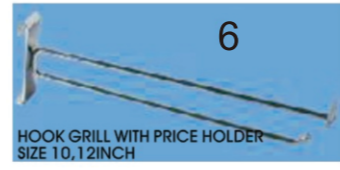

6

HOOK GRILL WITH PRICE HOLDER
SIZE 10,12INCH



7

GQ10079-FOOTALL HOLDER

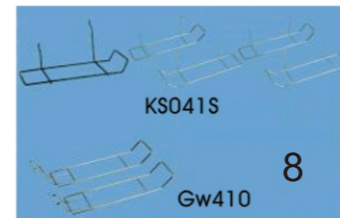

KS041S

8

Gw410



9

UHOOK6G-6
UHOOK8G-8



10

ARM ONE BALL
10,12,14,16"WITH BALL

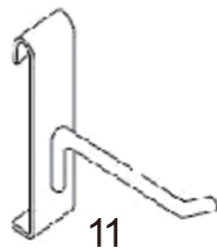

11

ITEM	L	ITEM	L
GA1084-2	2"	GQ1082	8"
GQ1084-4	4"	GQ1084	10"
GQ1083	6"	GQ1080	12"

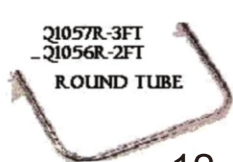

12

Q1057R-3FT
Q1056R-2FT
ROUND TUBE



13

GQ1056-2FT
GO1057-3FT
OVAL TUBE



14

SLI3019-VK.SI6-12P



15

PLASTICLOCK 1



16

B12128

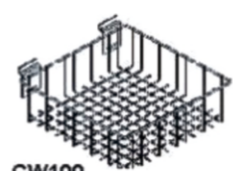

17

GW100



18

GW98



19

GW98-24X12X6



20

BSK10GW



21

GWS97

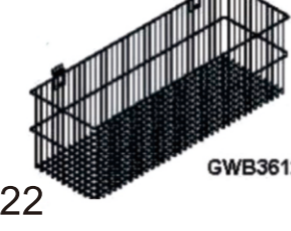

22

GWB36126



23

BT16S



END SYSTEM & GLOBAL

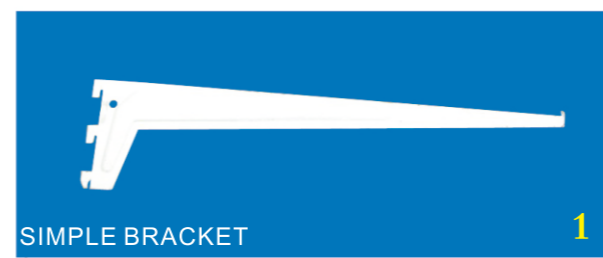

1

SIMPLE BRACKET
SIZE:450 500 600



2

I-BRACKET
SIZE:150 200 250 300 350 400



3

TP7 ADHERNET BAR L60.90.100.120



4

U BRACKET
SIZE:170 230 270 330 370 400



5

ADJUSTABLE BRACKET
SIZE:250 300 350 400

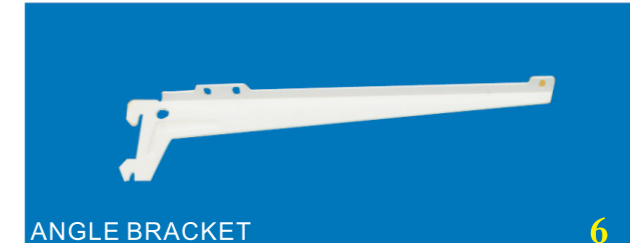

6

ANGLE BRACKET
SIZE:250 280 330 380



7

SINGLE UPRIGHT
SIZE:1.5,2.0,2.5,3.0METER
L/R

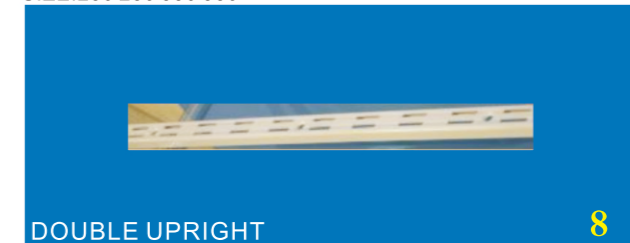

8

DOUBLE UPRIGHT
SIZE:1.5,2.0,2.5,3.0METER



9

A12G BRACKET
SIZE:250 300 350 400

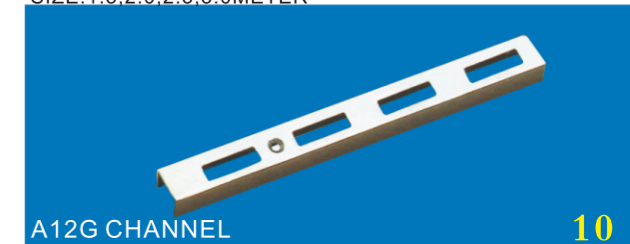

10

A12G CHANNEL
SIZE:1.0M 1.5M 2.0M 2.5M

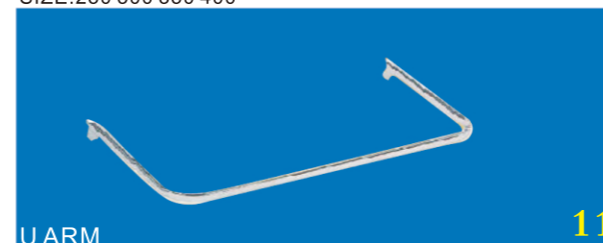

11

U ARM
SIZE:600 900 1200



12

A12G CHANNEL WITH DESIGN
SIZE:1.0M 1.5M 2.0M 2.5M



JAPANESE CHANNEL

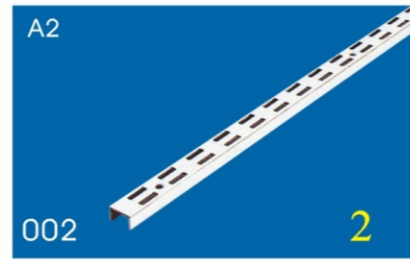

SIZE: 1.5M 2.0M 2.5M



SIZE: 1.5M 2.0M 2.5M

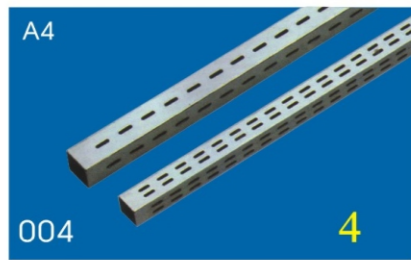

SIZE: 1.5M 2.0M 2.5M



SIZE: 1.5M 2.0M 2.5M



SIZE: 1.5M 2.0M 2.5M

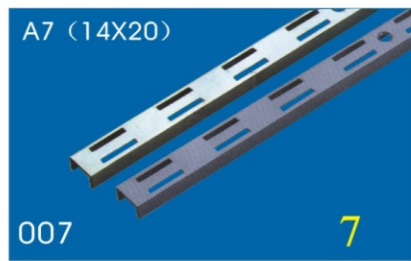

SIZE: 1.5M 2.0M 2.5M

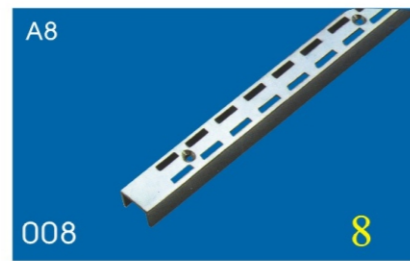

SIZE: 1.5M 2.5M



SIZE: 1.5M 2.0M 2.5M



SIZE: 1.5M 2.0M 2.5M



SIZE: 1.5M 2.0M 2.5M 3.0M



SIZE: 1.5M 2.0M 2.5M 3.0M



SIZE: 1.5M 2.0M 2.5M

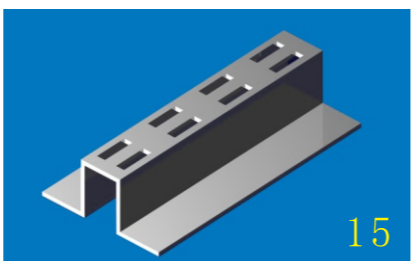

SIZE: 1.5M 2.0M 2.5M



BRACKET AND ACCESSORIES

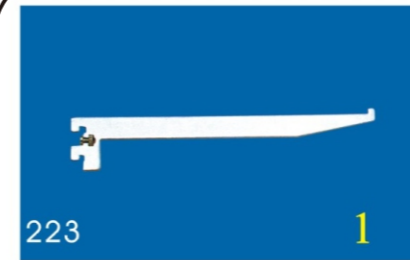

SIZE: 150 180 210 250 300 360



SIZE: 150 180 210 255 300 360



SIZE: 350 400



SIZE: 150 180 210 250 300 360

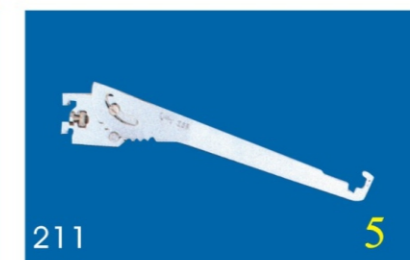

SIZE: 200 250 300 360 400



SIZE: 150 180 210 255 300 360 400 450



SIZE: 250 300 350

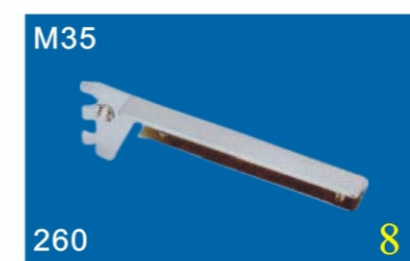

SIZE: 250 300 350 400



SIZE: 150 180 210 255 300 360

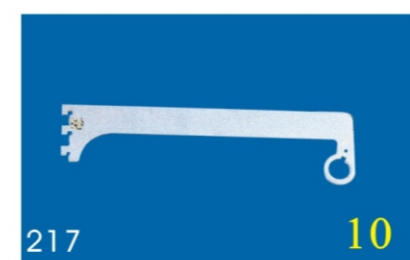

SIZE: 250 300 350 400



SIZE: 150 200 250 300 350 400 450

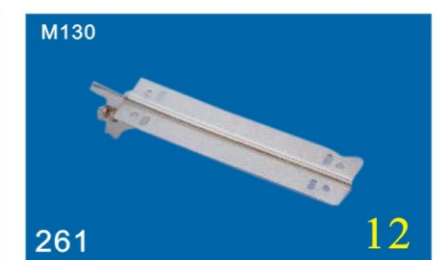

SIZE: 150 200 250 300 350 400 450



zig zag-100CM
code-GQ052

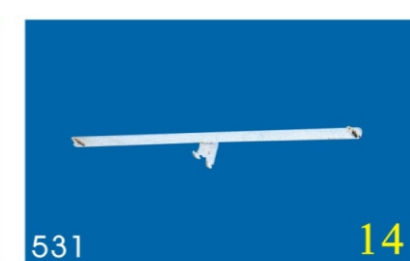

SIZE: 250 300 350 400



SIZE: 150 180 210 255 300 360 400 450



BRACKET AND ACCESSORIES



SIZE: Ø12



SIZE: 400 450

SIZE: 70 100 150 200 250 300



SIZE: 400 450

SIZE: 310 400

SIZE: 70-100 150 200 250 300

OVAL TUBE AND ACCESSORIES

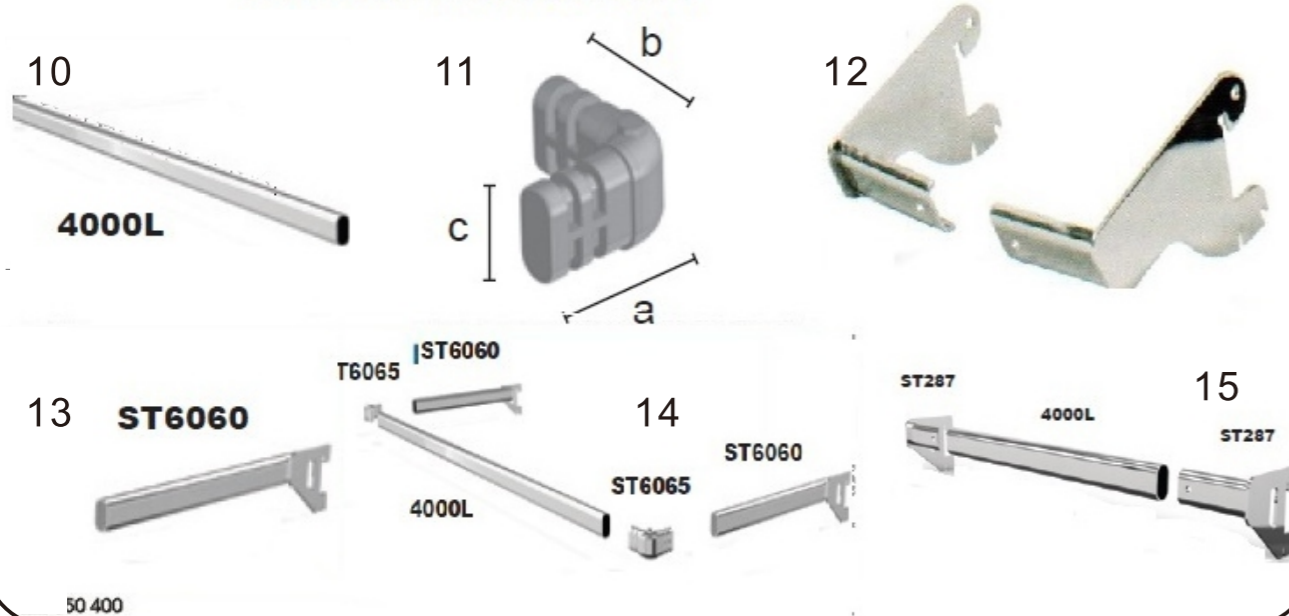

RECTANGLE BAR AND ACCESSORIES



SIZE: 70

SIZE: 1M 1.2M 1.5M 1.8M 2M 2.4M 2.8M 3M

AF52-30



SIZE: 400

SIZE: 350 400

SIZE: 400 450



SIZE: 400

SIZE: 400

SIZE: 450



SIZE: 400

SIZE: 415

SIZE: 400









VH14-1B VH16-1B

SIZE: 400

SIZE: 350

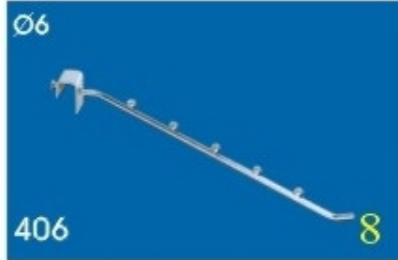
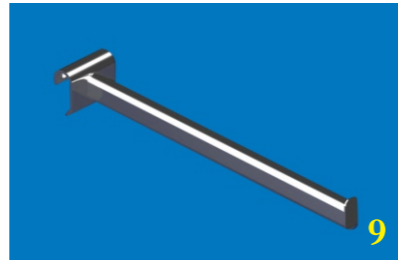









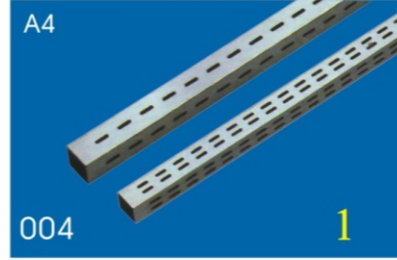

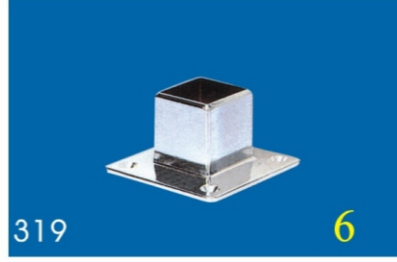

RECTANGLE BAR AND ACCESSORIES

 RH12-1B 1	 □19 439 2	 TP110 3
SIZE: 350 400		
 SUTP87 4	 ∅6 449 5	 ∅10 548 6
SIZE: 150 200	SIZE: 150 200 250 300 350	SIZE: 300
 ∅6 403 7	 ∅6 406 8	 VH14-1B/VH161B-35 N 40CM 9
SIZE: 100 150 200 250 300 350	SIZE: 100 150 200 250 300	
 ∅9 494 10	 ∅9 443 11	 ∅9 442 AF54-35CM 12
SIZE: 310 400	SIZE: 300 350	SIZE: 300 350
 ∅10 AF52-40 AF52-35 13	 ∅10 AF13-1B 14	 VH36U U ARM FOR OVAL TUBE 15

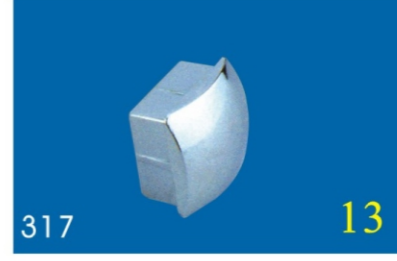

RECTANGLE AND ROUND POST ACCESSORIES

 A4 004 1	 ∅32 ∅38 ∅50 005 2	 309 3
SIZE: 1.5M 2.0M 2.5M	SIZE: 1.5M 2.0M 2.5M	SIZE: 25x25 30.5x30.5 38x38
 SM343T 4		 344 5
 319 6	 323 7	 S HOOK 338 8
SIZE: 25x25 30x30 38x38	SIZE: ∅32 ∅38 ∅50	
 (圓) SM333 9	 SM339 10	 L-002 11
 316 12	 317 13	 318 SM381-50 14
SIZE: 16X32	SIZE: 25X25 30X30 38X38	SIZE: ∅32 ∅38 ∅50



JOKER SYSTEM

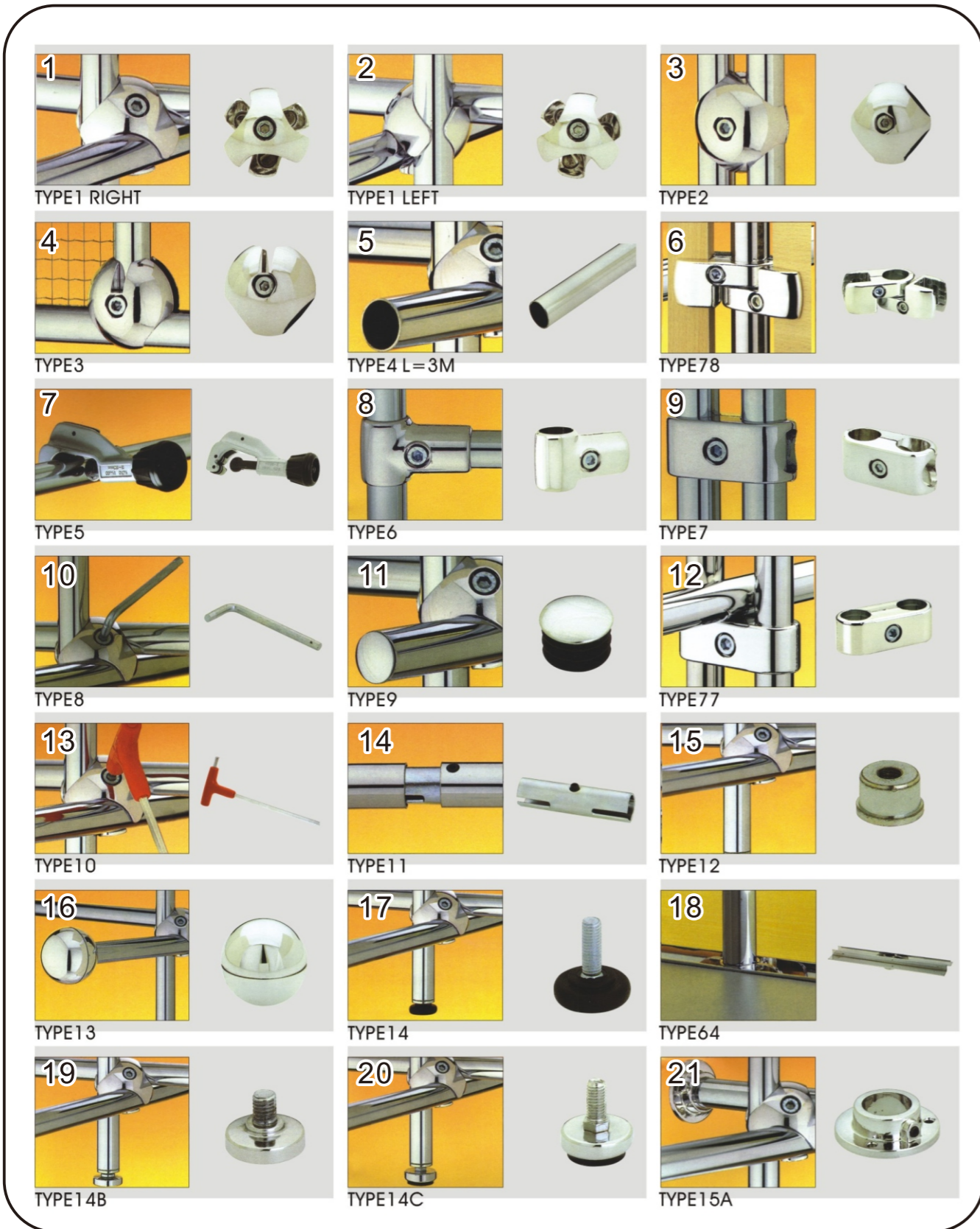

JOKER SYSTEM

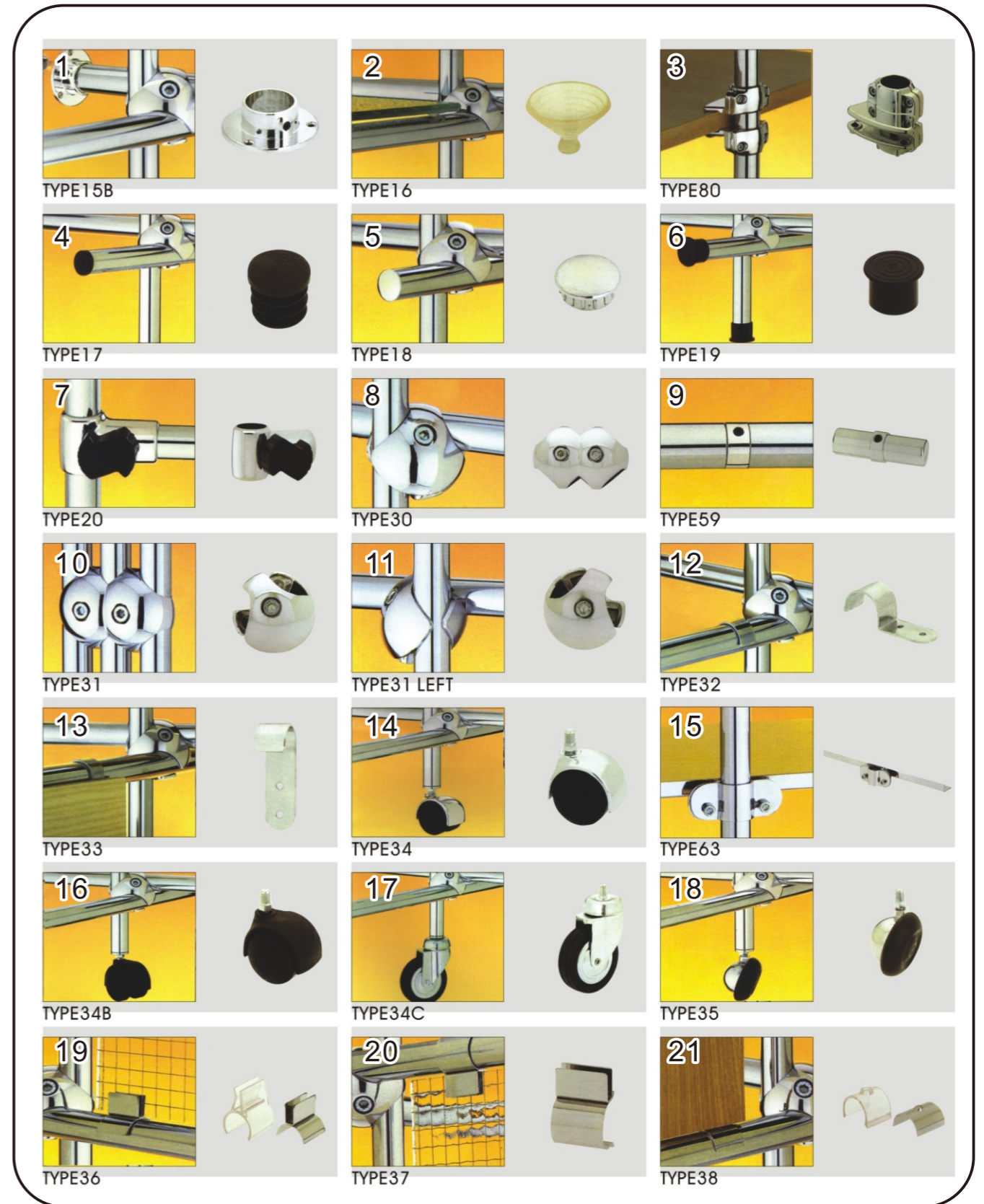



JOKER SYSTEM



TYPE39

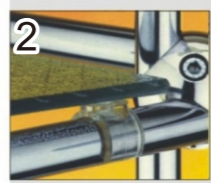

TYPE40

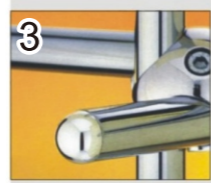

TYPE41

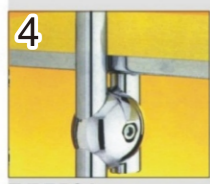

TYPE50A

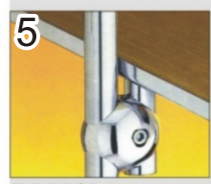

TYPE50B



TYPE50C

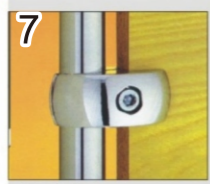

TYPE51

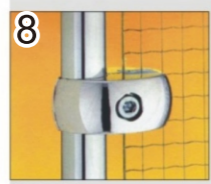

TYPE52



TYPE53

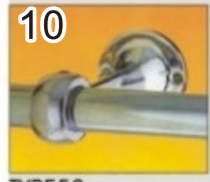

TYPE58

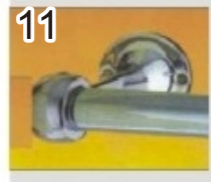

PHOLDER



TYPE82



TYPE11



TYPE81



TYPE80



PIPUNIT



PRIMO SYSTEM



Type 1
Giunto a 3 vie in zana.
3-way joint.
3-Weg Verbinder.
Joint à 3 voies.
Крепок с 3-ми направлениями.

Ex.	Dim. (mm)	Cod.
	20 x 20	PS0101-0000
	25 x 25	PS0102-0000



Type 6
Giunto a 3 vie a "T" in zana.
3-way "T" shaped joint.
3-Weg "T" förmig Verbinder.
Joint à 3 voies à "T".
Крепок "Т"-образный с 3-ми направлениями.

Ex.	Dim. (mm)	Cod.
	20 x 20	PS0601-0000
	25 x 25	PS0602-0000



Type 2
Giunto a 4 vie in zana.
4-way joint.
4-Weg Verbinder.
Joint à 4 voies.
Крепок с 4-ми направлениями.

Ex.	Dim. (mm)	Cod.
	20 x 20	PS0201-0000
	25 x 25	PS0202-0000



Type 7
Giunto a 4 vie a croce in zana.
4-way cross-joint.
4-Weg kreuzförmiger Verbinder.
Joint à 4 voies à croix.
Крепок крестообразный с 4-ми направлениями.

Ex.	Dim. (mm)	Cod.
	20 x 20	PS0701-0000
	25 x 25	PS0702-0000



Type 3
Giunto a 5 vie in zana.
5-way joint.
5-Weg Verbinder.
Joint à 5 voies.
Крепок с 5-ю направлениями.

Ex.	Dim. (mm)	Cod.
	20 x 20	PS0301-0000
	25 x 25	PS0302-0000



Type 8
Tubo quadro.
Square tube.
Viereckrohr.
Tube carré.
Квадратная труба.

Dim. (mm)	Cod.
L.3000	
20 x 20 x 1,2	PS0801-0000
25 x 25 x 1,2	PS0802-0000



Type 4
Giunto a 6 vie in zana.
6-way joint.
6-Weg Verbinder.
Joint à 6 voies.
Крепок с 6-ю направлениями.

Ex.	Dim. (mm)	Cd.
	20 x 20	PS0401-00
	25 x 25	PS0402-00



Type 5
Giunto a 2 vie a "L" in zana.
2-way "L" shaped joint.
2-Weg "L" förmig Verbinder.
Joint à 2 voies à "L".
Крепок "L"-образный с 2-ми направлениями.











Ex.	Dim. (mm)	Cd.
	20 x 20	PS0501-00
	25 x 25	PS0502-00



PRTABL3LEVEL

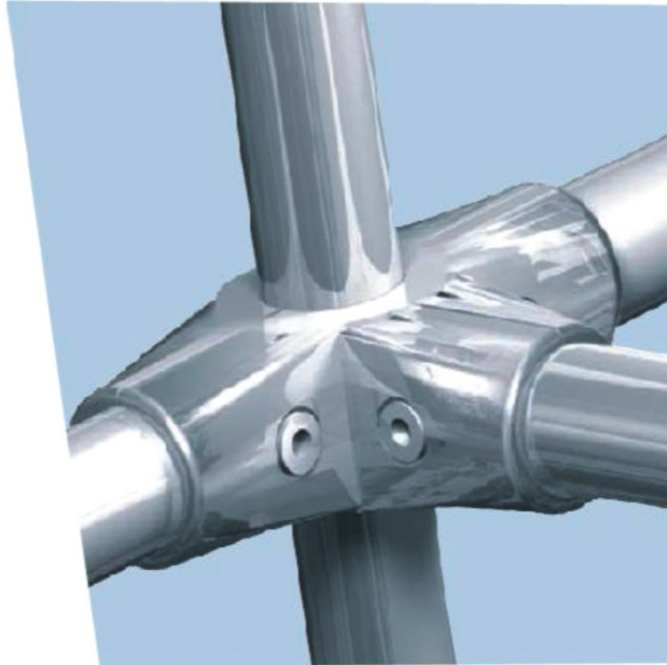

UNO SYSTEM

1	<p>Type 21 Giunto a 3 vie forte. 3-way strong clamp. 3-Weg Verbinder stark. Joint à 3 voies fort. Усиленный крепеж с 3-мя направлениями.</p> 	2	<p>Type 23 Giunto a 5 vie forte. 5-way strong clamp. 5-Weg Verbinder stark. Joint à 5 voies fort. Усиленный крепеж с 5-ю направлениями.</p> 
3	<p>Type 22 Giunto a 4 vie snodato forte. Articulated 4-way strong clamp. 4-Weg Gelenkverbinder stark. Joint à 4 voies desarticulé fort. Усиленный крепеж с 4-мя направлениями.</p> 	4	<p>Type 24 Giunto a 6 vie forte. 6-way strong clamp. 6-Weg Verbinder stark. Joint à 6 voies fort. Усиленный крепеж с 6-ю направлениями.</p> 
5	<p>Type 1 Giunto a 3 vie. 3-way clamp. 3-Weg Verbinder. Joint à 3 voies. Крепеж с 3-мя направлениями.</p> 	6	<p>Type 25 Supporto per i piani. Support for shelves. Panneelhalter. Support pour étagères. Полочкадержатель.</p> 
7	<p>Type 7 Giunto a 5 vie. 5-way clamp. 5-Weg Verbinder. Joint à 5 voies. Крепеж с 5-ю направлениями.</p> 	8	<p>Type 15 Giunto a 4 vie snodato. 4-way jointed clamp. 4-Weg Gelenkverbinder. Joint à 4 voies desarticulé. Крепеж поворотный с 4-мя направлениями.</p> 
9	<p>Type 4 Giunto a 4 vie ad angolo. 4-way corner clamp. 4-Weg Eckverbinder. Joint à 4 voies à angle. Крепеж угловой с 4-мя направлениями.</p> 		
10	<p>Type 16 Giunto parallelo per pannello o cristallo. Parallel clamp for panel or crystal. Parallelverbinder für Paneel oder Glass. Joint parallél pour panneau ou cristal. Крепеж параллельный для панели и стекла.</p> 		
11	<p>Type 19 Chiave per montatori. Screw spanner for assemblers. Schlüssel für Monteurs. Clé pour monteurs. Ключ для монтажа.</p> 		



DB-SYSTEM

1	2	
DB4021		
3	4	5
6		DB4020
8		7
DB4023		DB4026
10		9
DB4028		DB4024
11	12	



DRT-SYSTEM

1 DRT107

2

3

4 DRT102

5 DRT-13

6 DRT114/01-L-390

7 DRT100

8 DRT111/01

9 DRT103

10

11 DRT108

12 DRT106

13 DRT108-WITH GLASS

14 DRT105

15 DRT-101

16 DRT101-WITH GLASS

17

18 DRT113-300MM

19

20 DRT113- Set
1Glass 300x90mm
1Pair DRT113
1Pc- Pipe 25mmx92c



SOCKET SYSTEM

1 DB4043

2

3 DB4044

4 DB4050

5

6 SOCKET-A

7 DB4040

8 SOCKET-B

9 DB4041

10 SOCKET-F

11 SOCKET-C

12 DB4043

13 SOCKET-D

14 DB4041/19

15 SOCKET-E

DB4052



OPTICO SYSTEM



PUCK SYSTEM

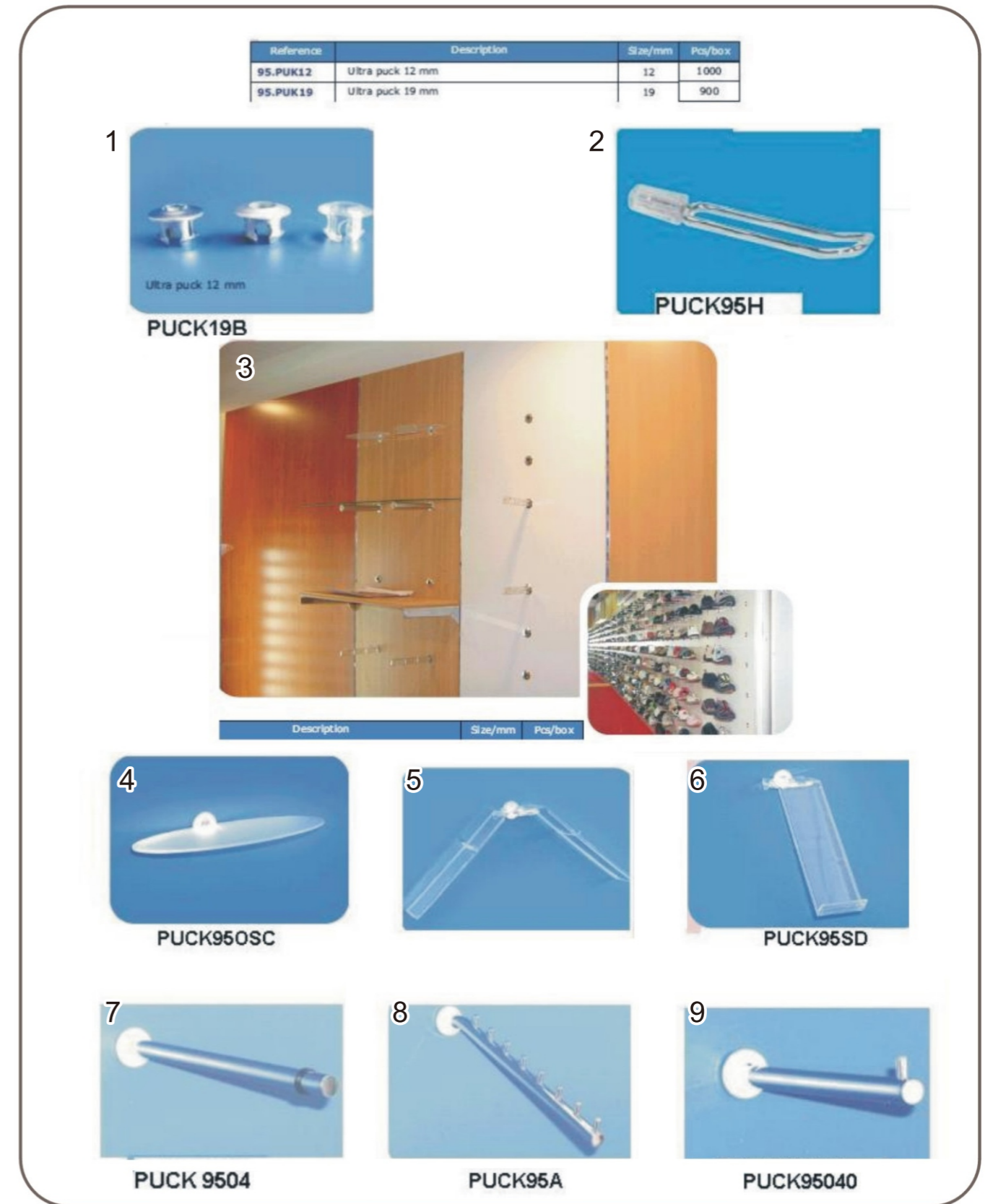



GLASS CLIP AND ACCESSROIES



BUST

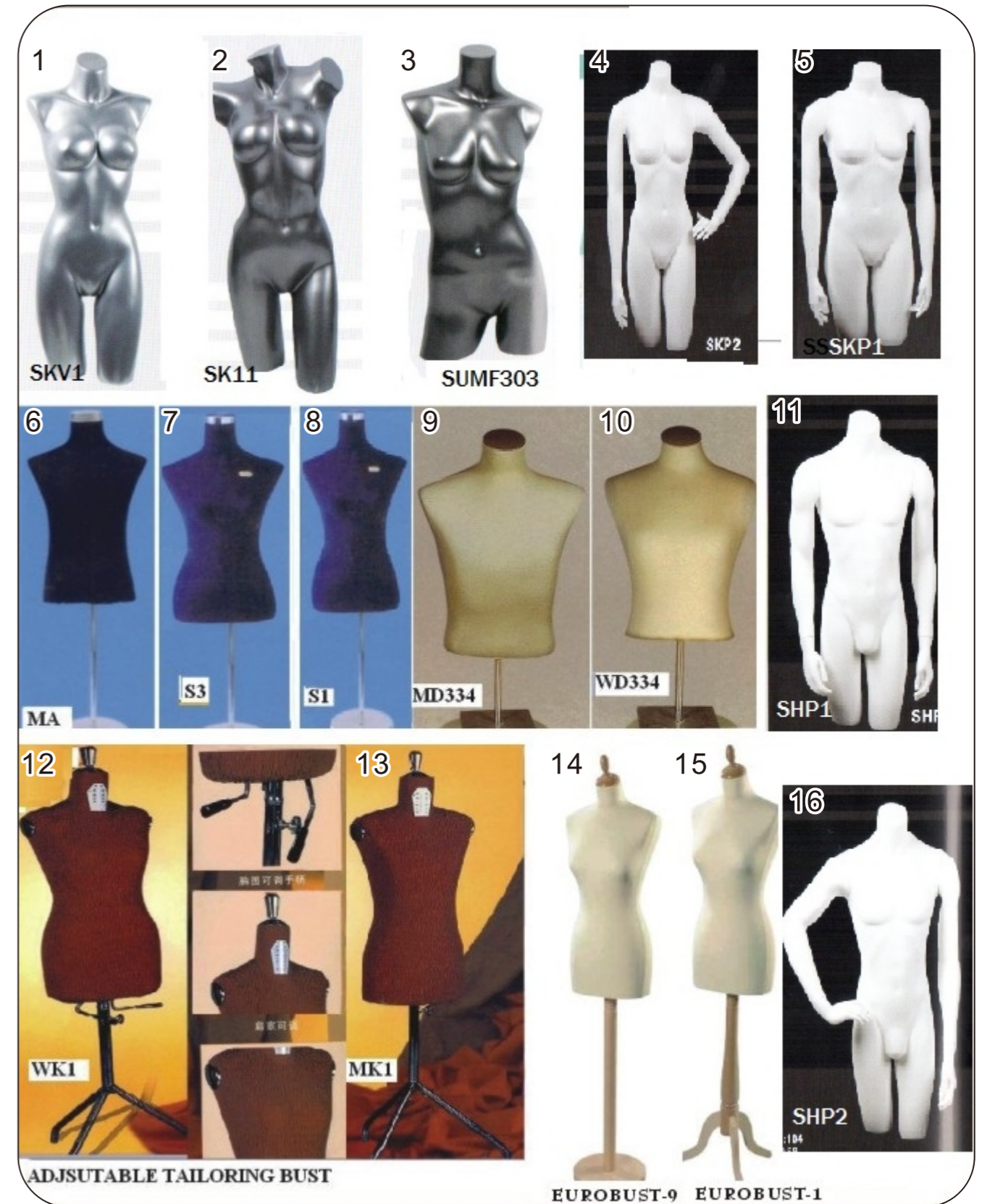



TORSO



MANNEQUINS HEADLESS AND HALF HEAD

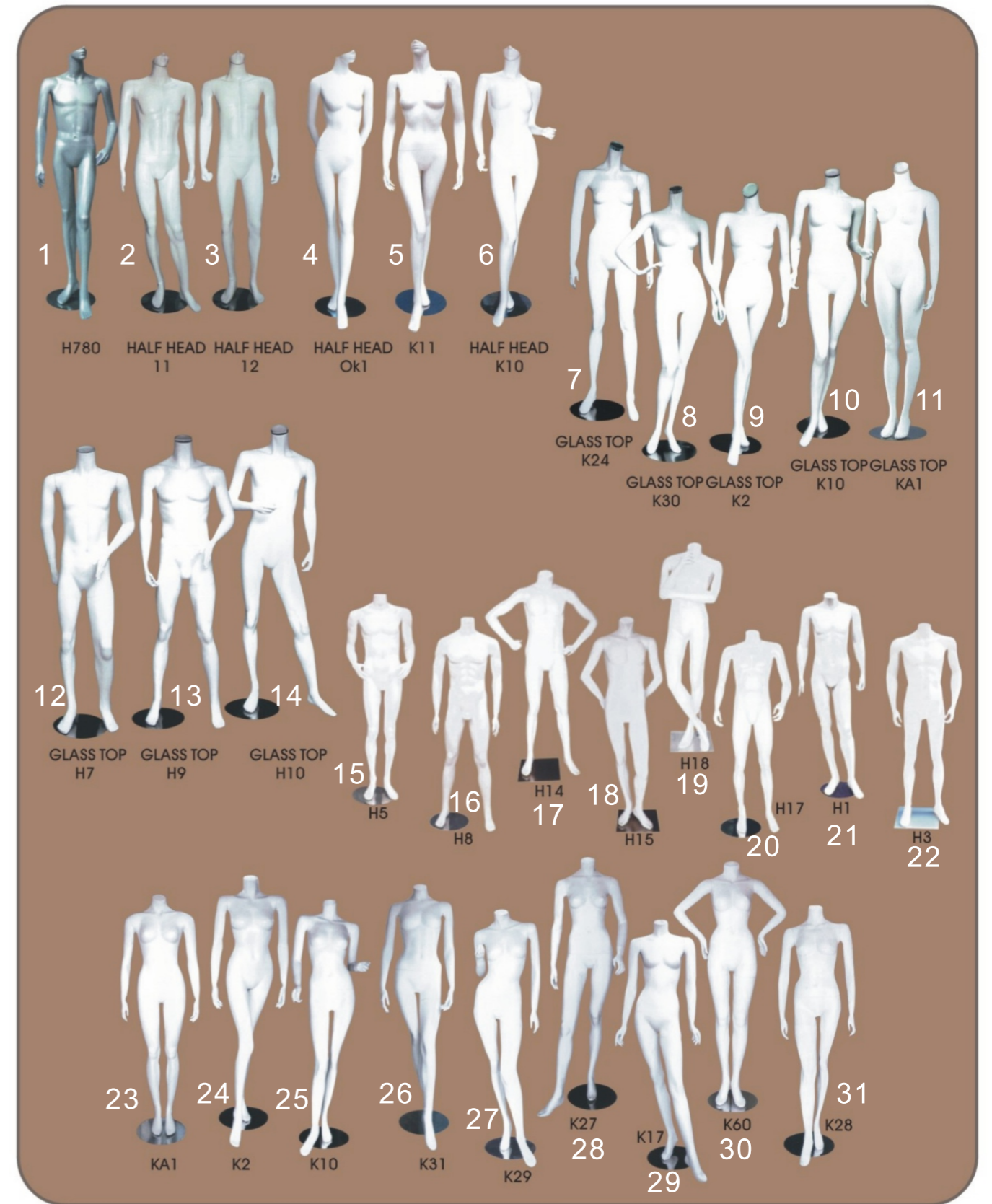



MANNEQUINS KIDS NEW

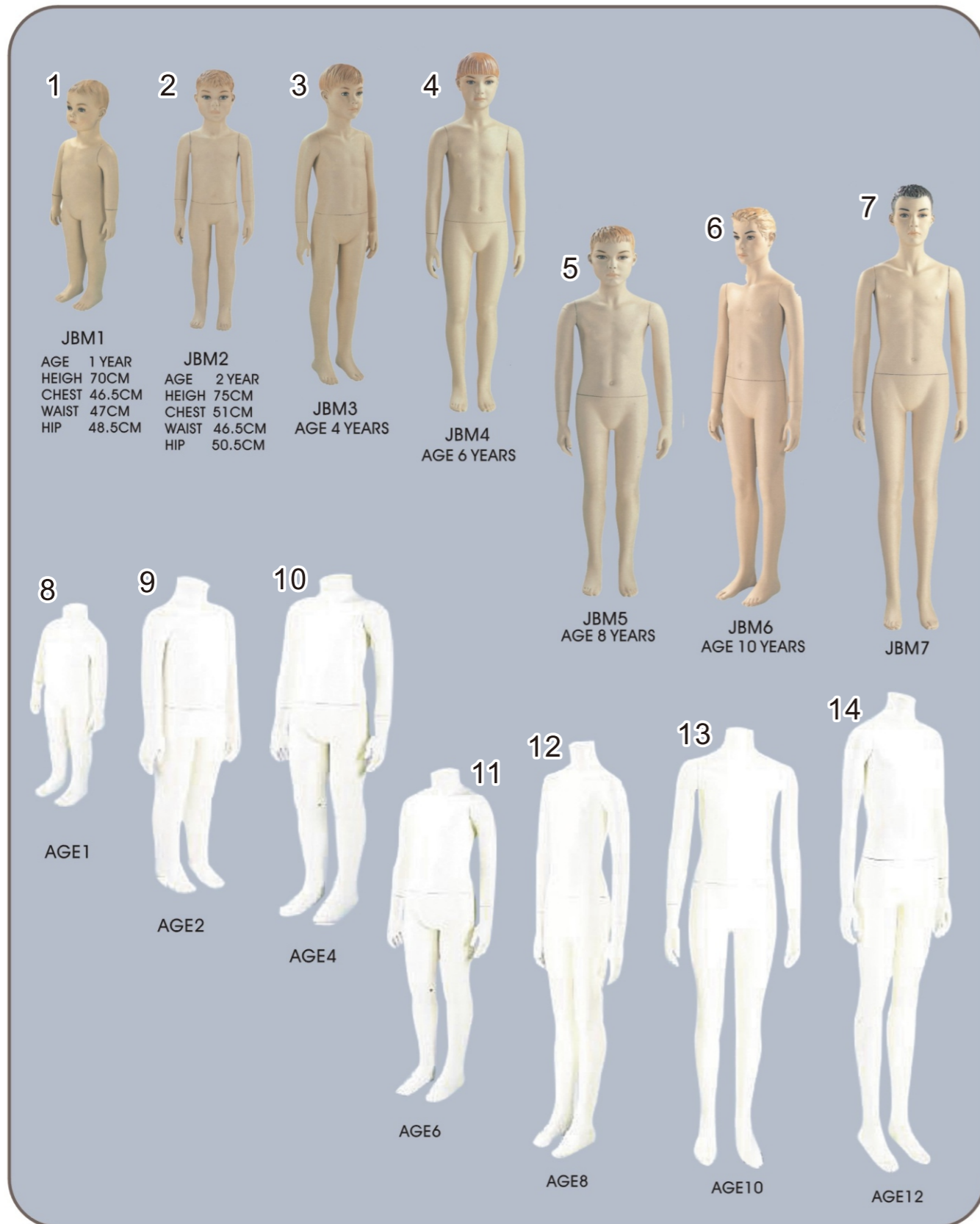

MANNEQUINE KIDS NEW

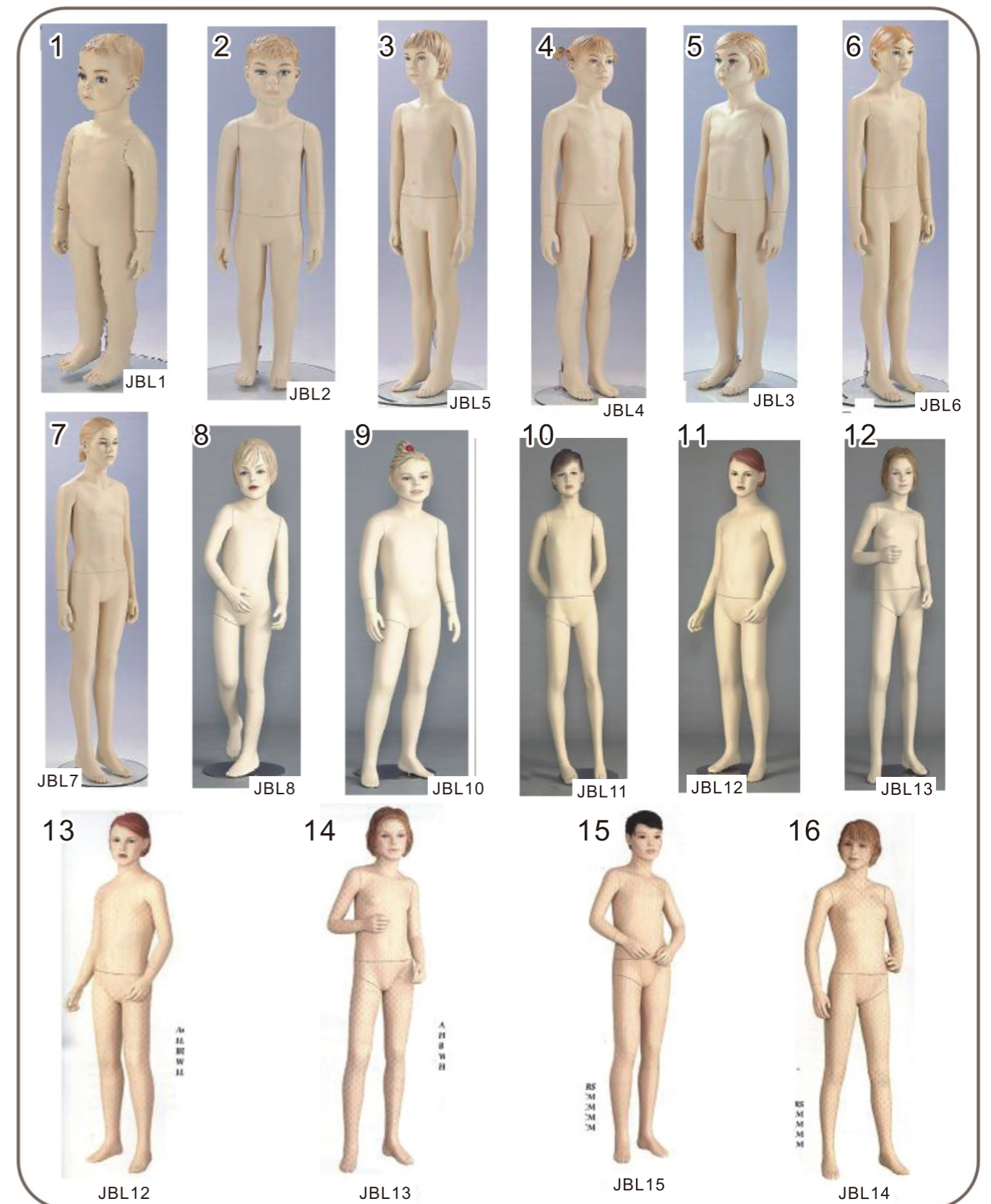



MANNEQUINE KIDS NEW

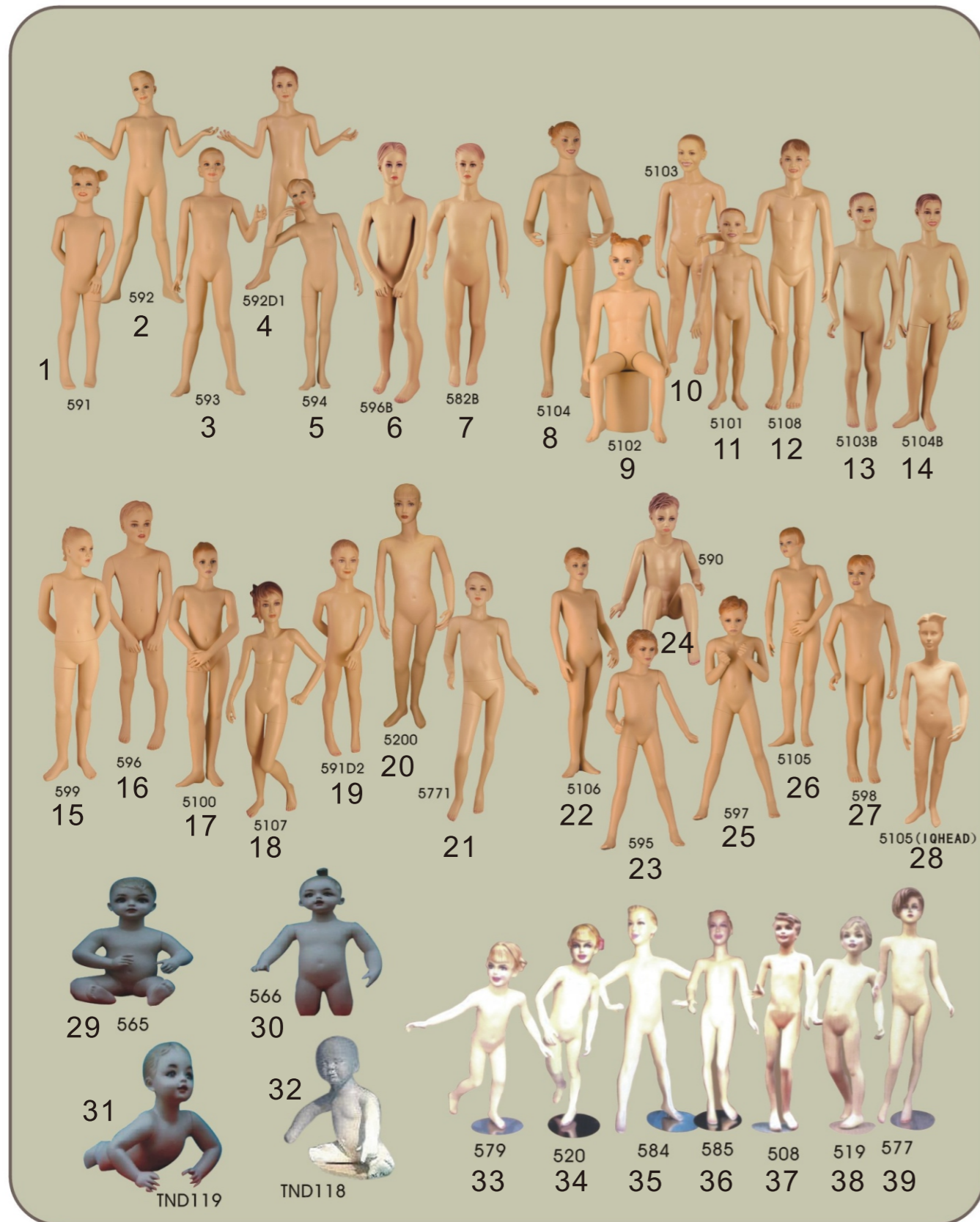

MANNEQUINS SCULPTURE HEAD





MANNEQUINS SCULPTURE HEAD

1 A188 HE: 185cm B : 84cm SH: 40cm W : 60cm H : 88cm	2 AK20 HE: 185cm B : 80cm SH: 44cm W : 58cm H : 86cm	3 AK17 HE: 182cm B : 87cm SH: 42cm W : 59cm H : 88cm	4 AK61 HE: 172cm B : 86.5cm SH: 39cm W : 56.5cm H : 88cm	5 AK22 HE: 188cm B : 80cm SH: 44cm W : 60cm H : 89cm	6 AK26 HE: 185cm B : 80cm SH: 42cm W : 59cm H : 86cm	7 AK30 HE: 178cm B : 80cm SH: 39cm W : 57cm H : 87.5cm
8 BL7 HE: 181cm B : 82.5cm SH: 42cm W : 62cm H : 88.5cm	9 BL4 HE: 185cm B : 84cm SH: 39cm W : 63cm H : 88cm	10 BL3 HE: 182cm B : 84cm SH: 40cm W : 62cm H : 90cm	11 BL13 HE: 180cm B : 84.5cm SH: 38.5cm W : 63.5cm H : 87.5cm	12 BL12 HE: 180cm B : 84cm SH: 41cm W : 61.5cm H : 87cm	13 BL15 HE: 182cm B : 87cm SH: 42cm W : 61.5cm H : 89cm	14 BL21 HE: 179cm B : 79cm SH: 40cm W : 60.5cm H : 88cm
15 BL8 HE: 183cm B : 81cm SH: 40cm W : 62cm H : 87cm	16 BL11 HE: 175cm B : 78cm SH: 41cm W : 59cm H : 87cm	17 BL15-BL11 HE: 182cm B : 87cm SH: 42cm W : 61.5cm H : 89cm	18 BL23 HE: 181cm B : 79cm SH: 42cm W : 59cm H : 87.5cm	19 RK68 HE: 177cm B : 82.5cm SH: 38cm W : 61.5cm H : 89cm	20 RK70 HE: 177cm B : 88cm SH: 38cm W : 63cm H : 88cm	



MANNEQUINE WITH EGG HEAD

1 JL4EGC129	2 JLEF39C129	3 JLEF323C129	4 JLNEF203C129	5 JLNEF204C129
6 JLNEF205C129	7 TND67CB	8 TND68CY	9 TND68CG	10 RAM2GW
11 JMEM229C129	12 JMEM27C129GB	13 JMEM212C129	14 JMEM27C129GB	



MANNEQUINE - NEW

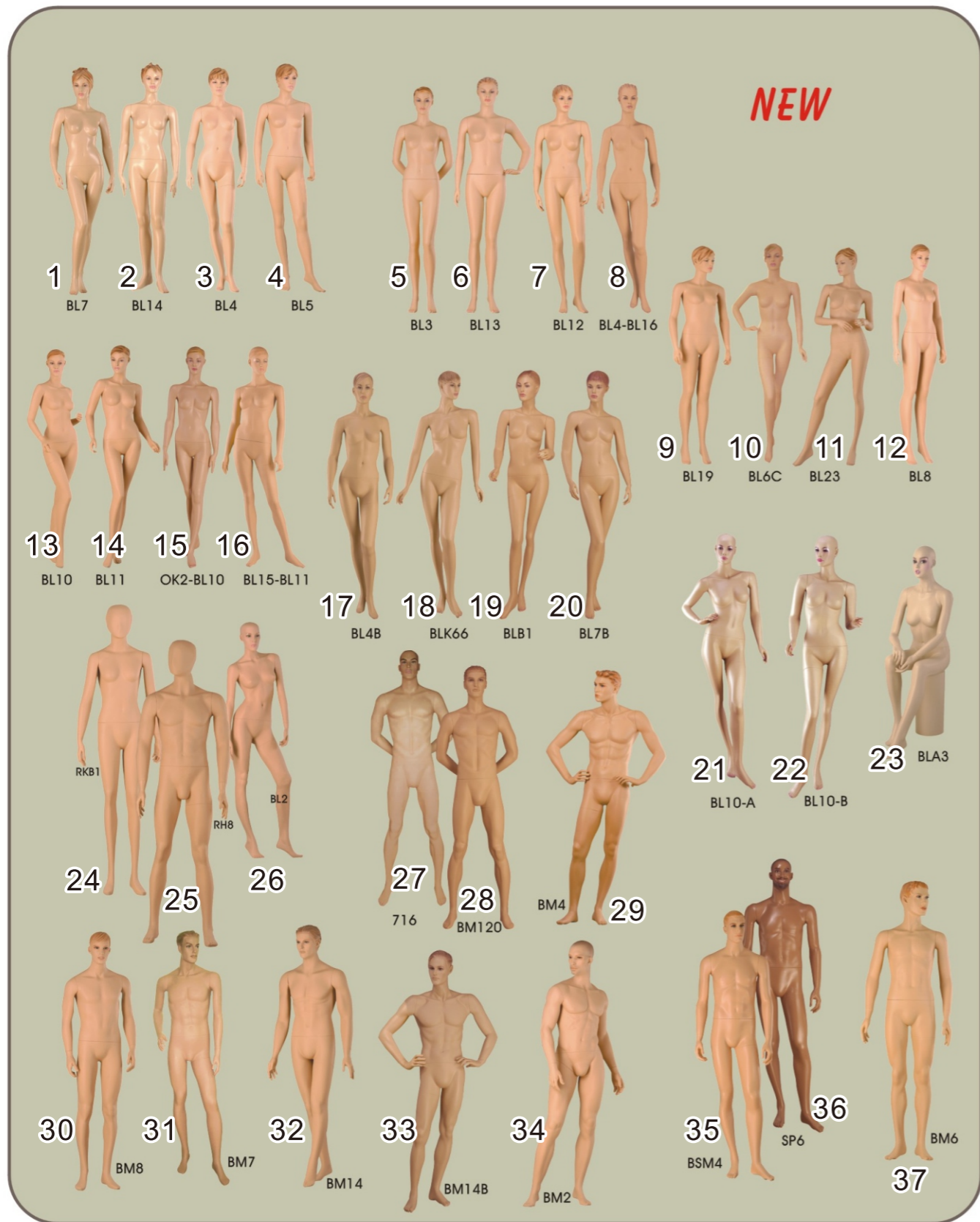

MANNEQUINS NEW JLSERIES

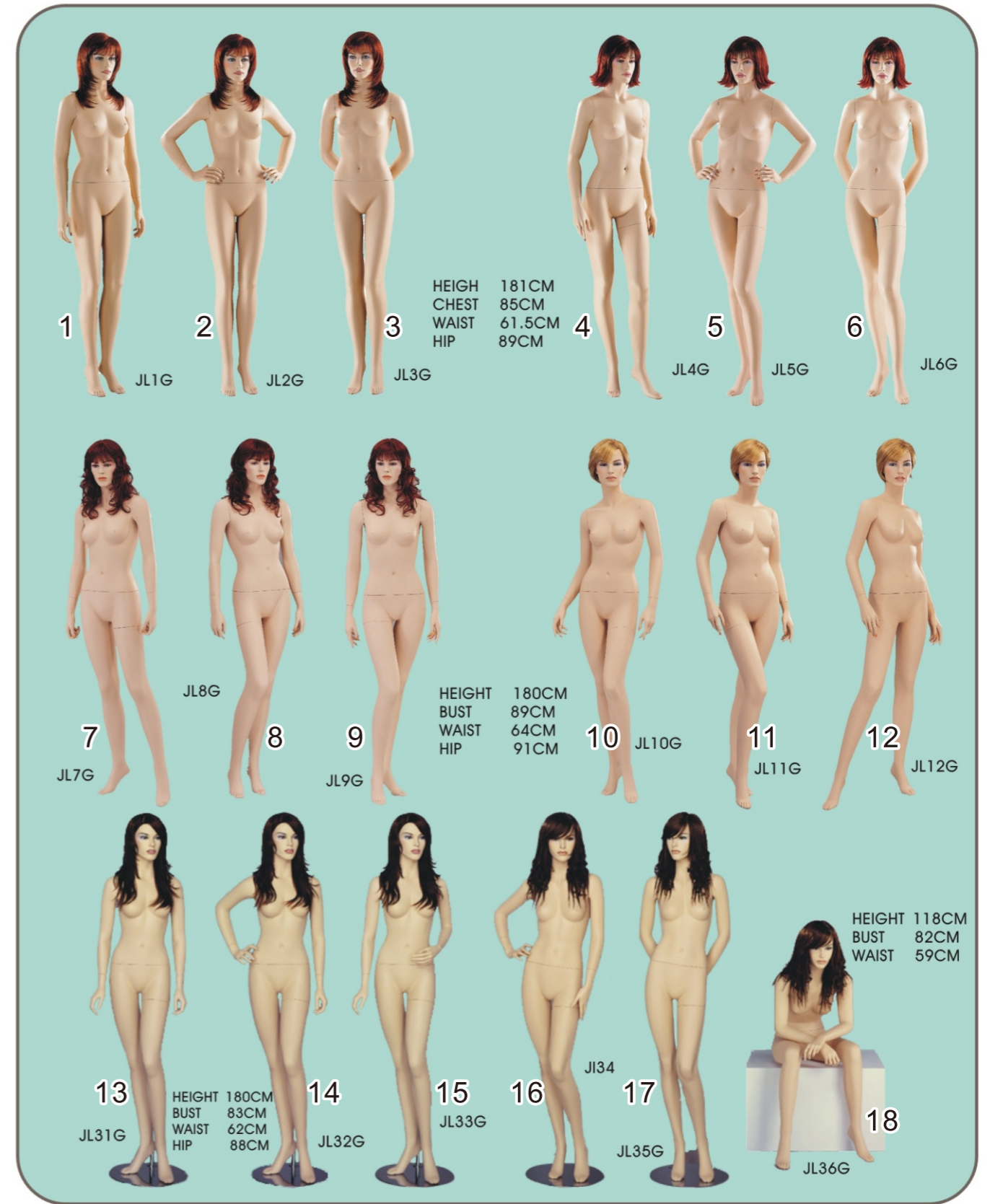



MANNEQUINS NEW JLSERIES

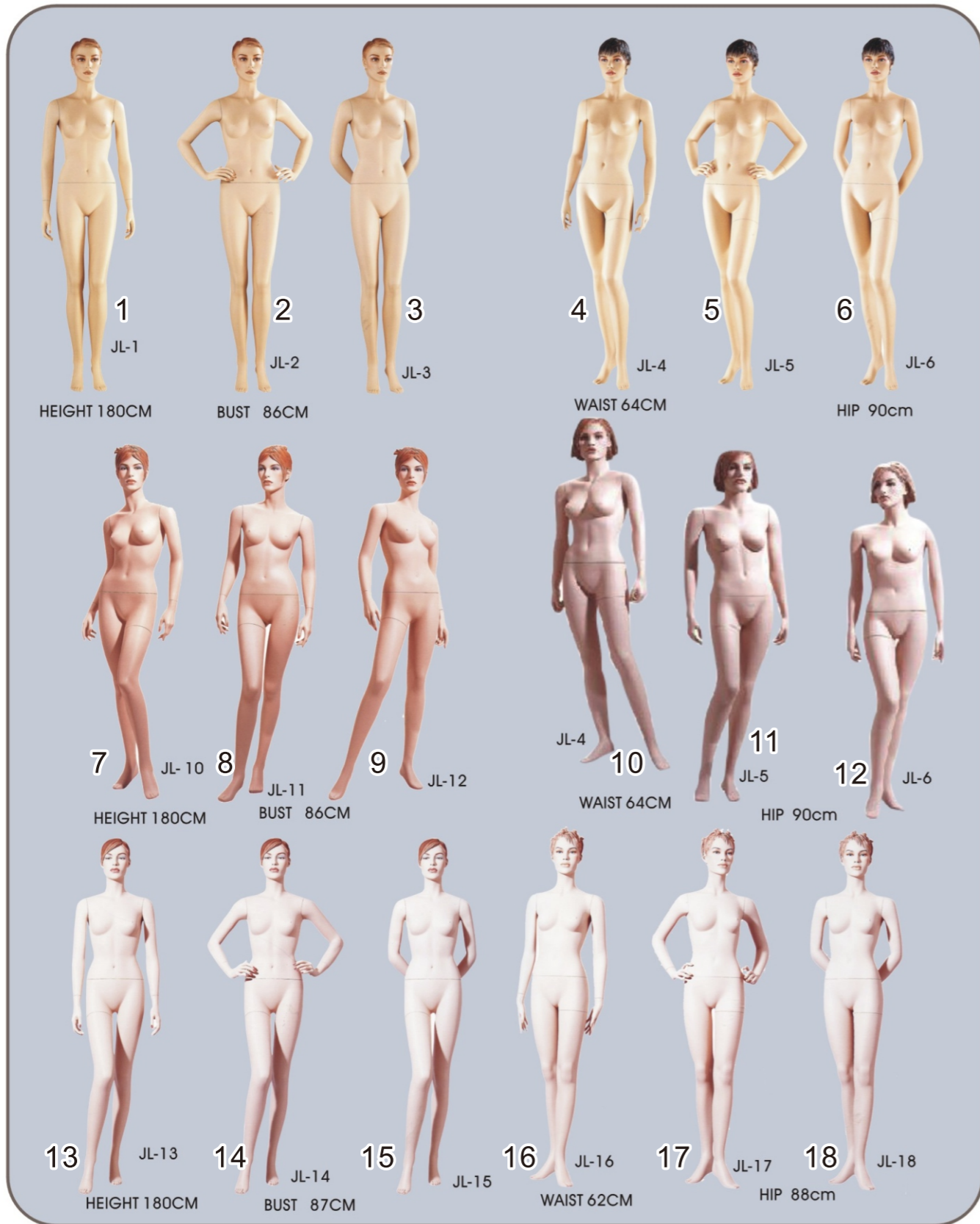

AFRICAN MANNEQUINE





HEADLESS AND SPORT

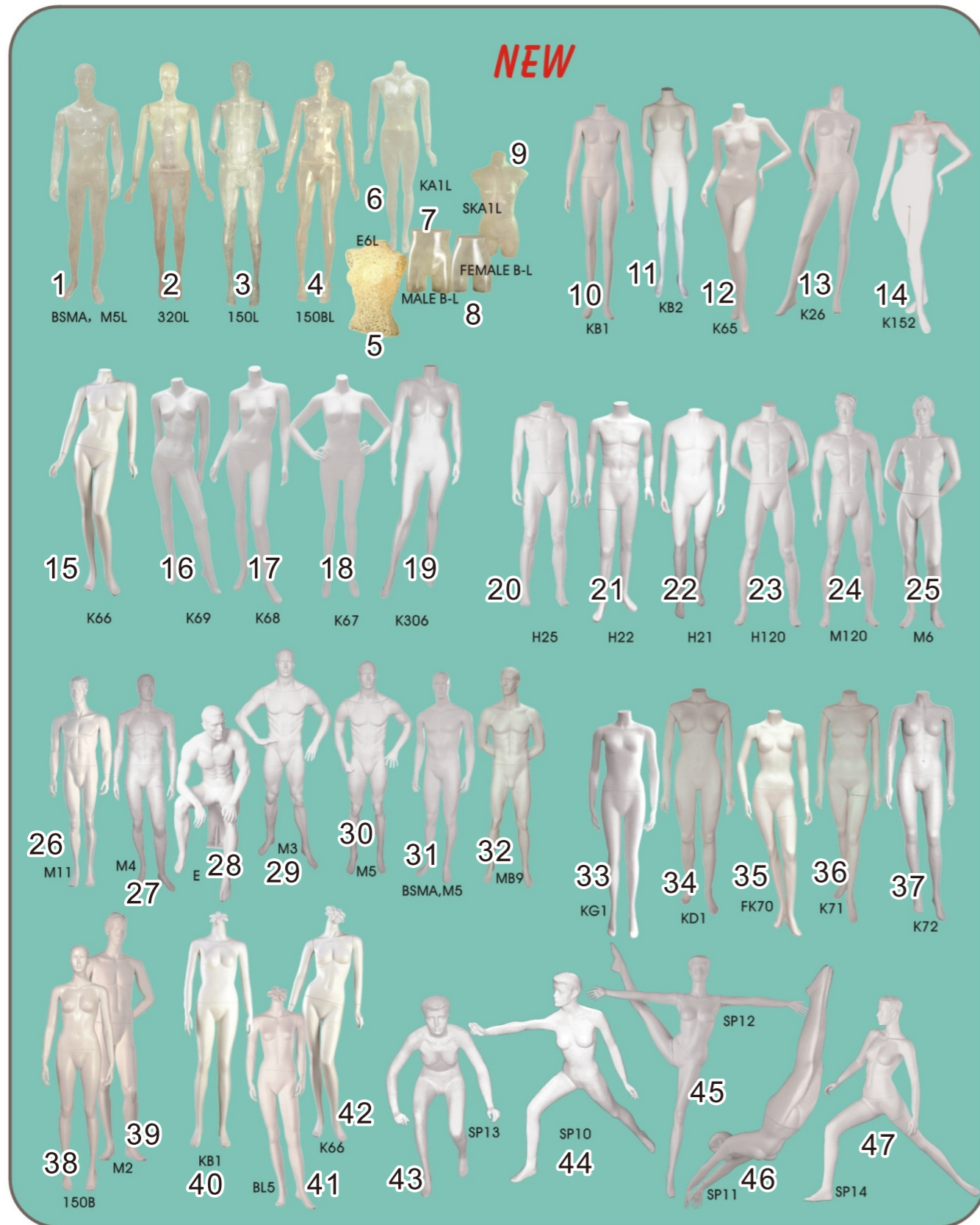

WOODEN HANGER

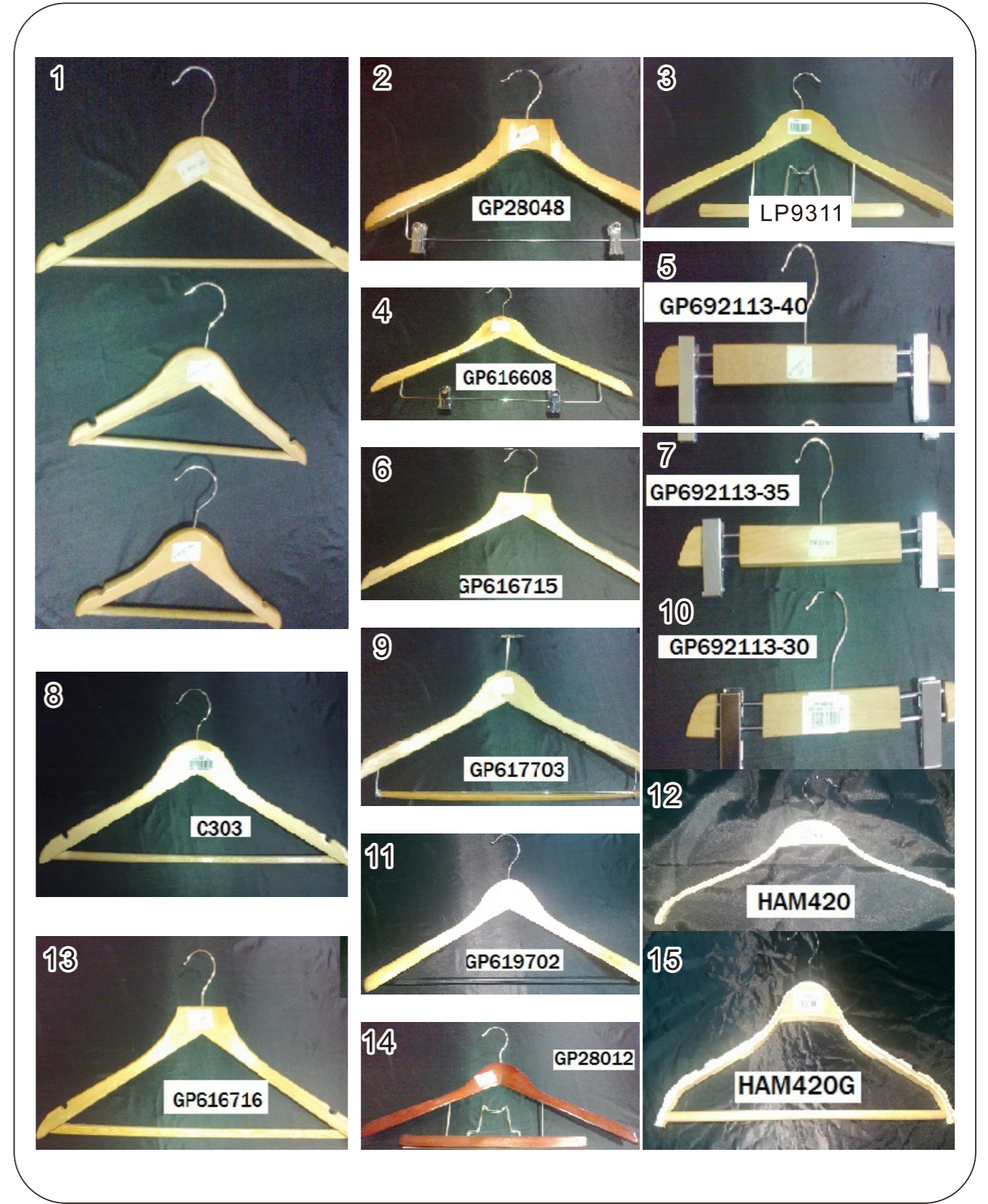



PLASTIC HANGERS

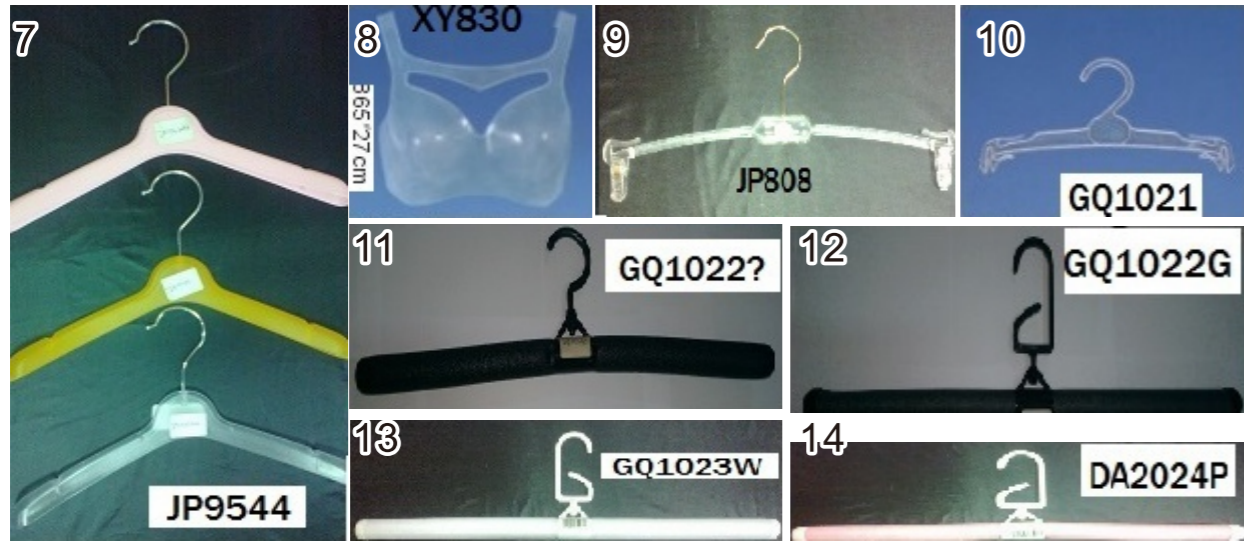
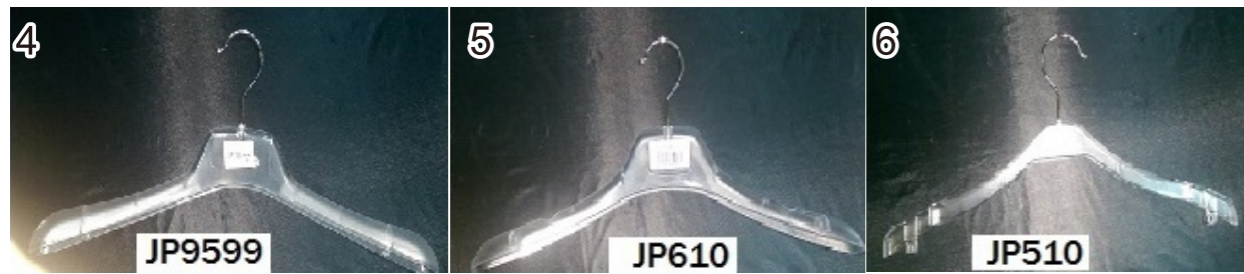
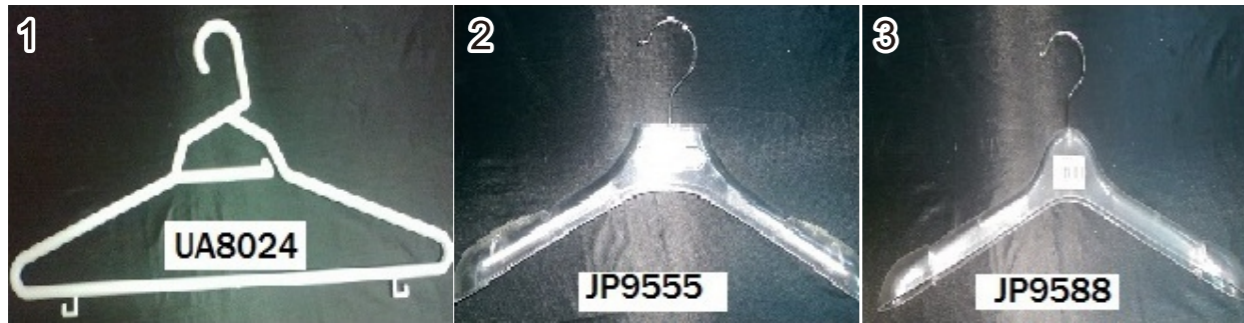

PLASTIC HANGER

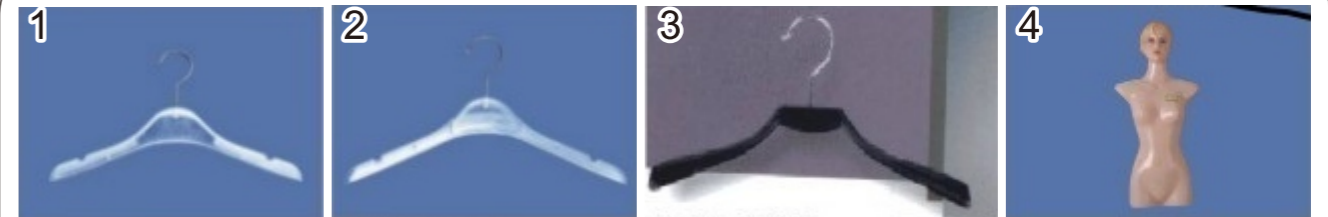

9500A 36cm 9500B 39.5cm JP630-33CM XY880

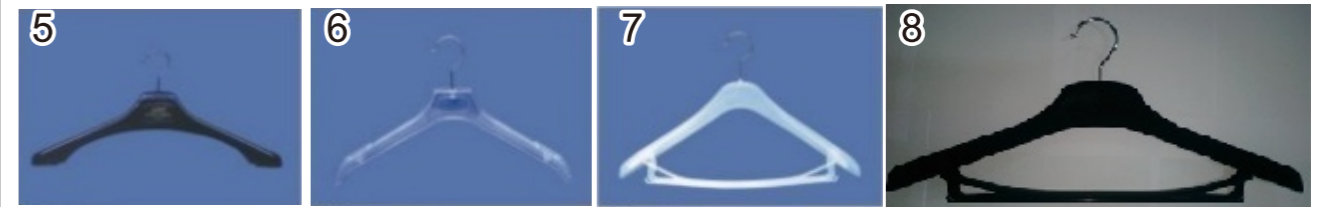

607 47.5cm 608 38.5cm 111 43cm 505

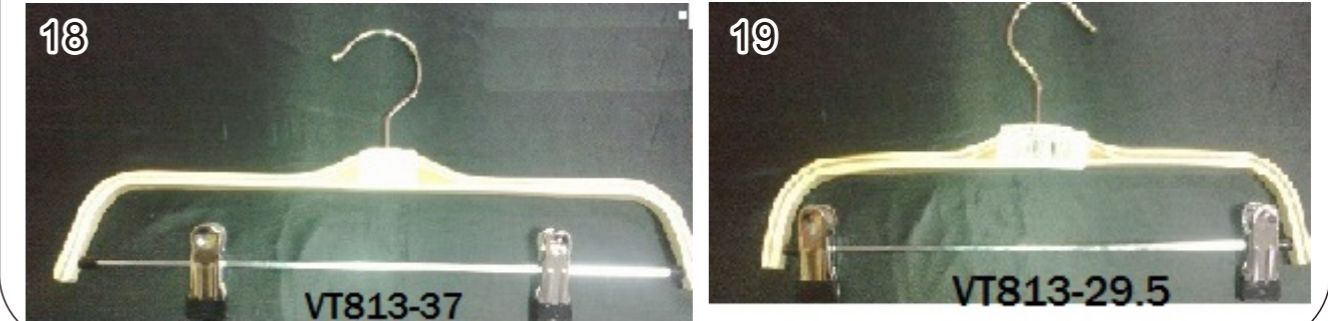
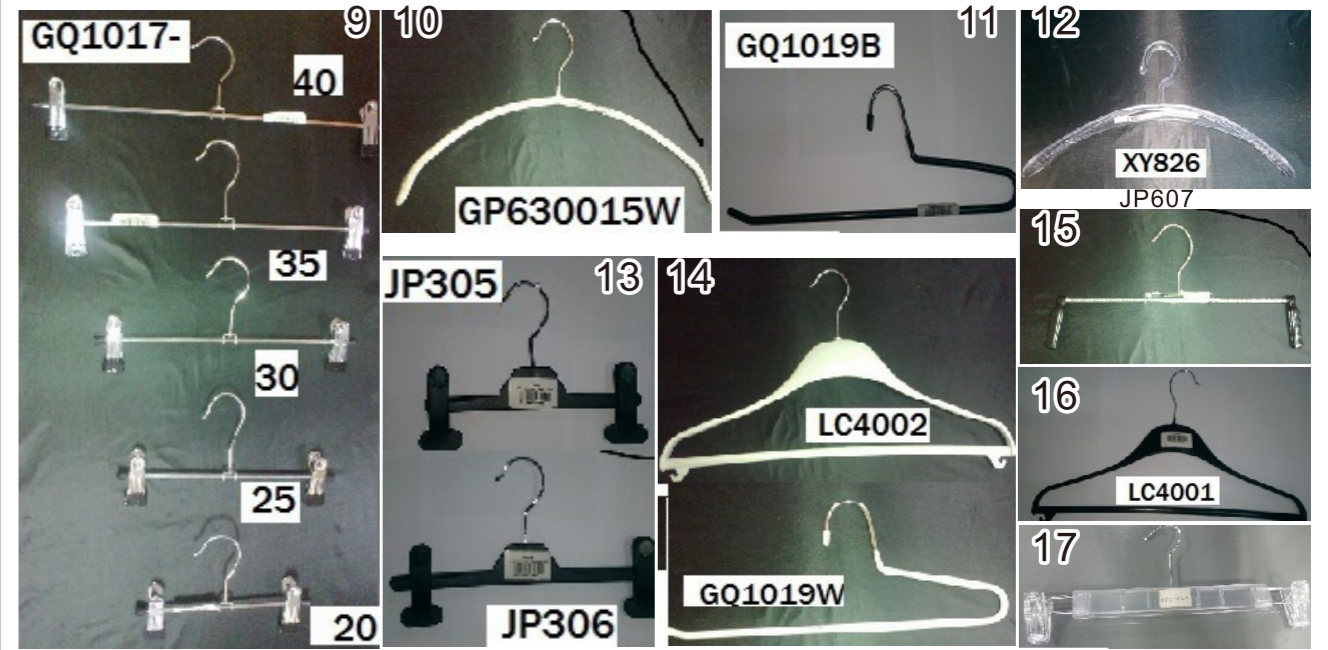

VT813-37 VT813-29.5



PLASTIC HANGER

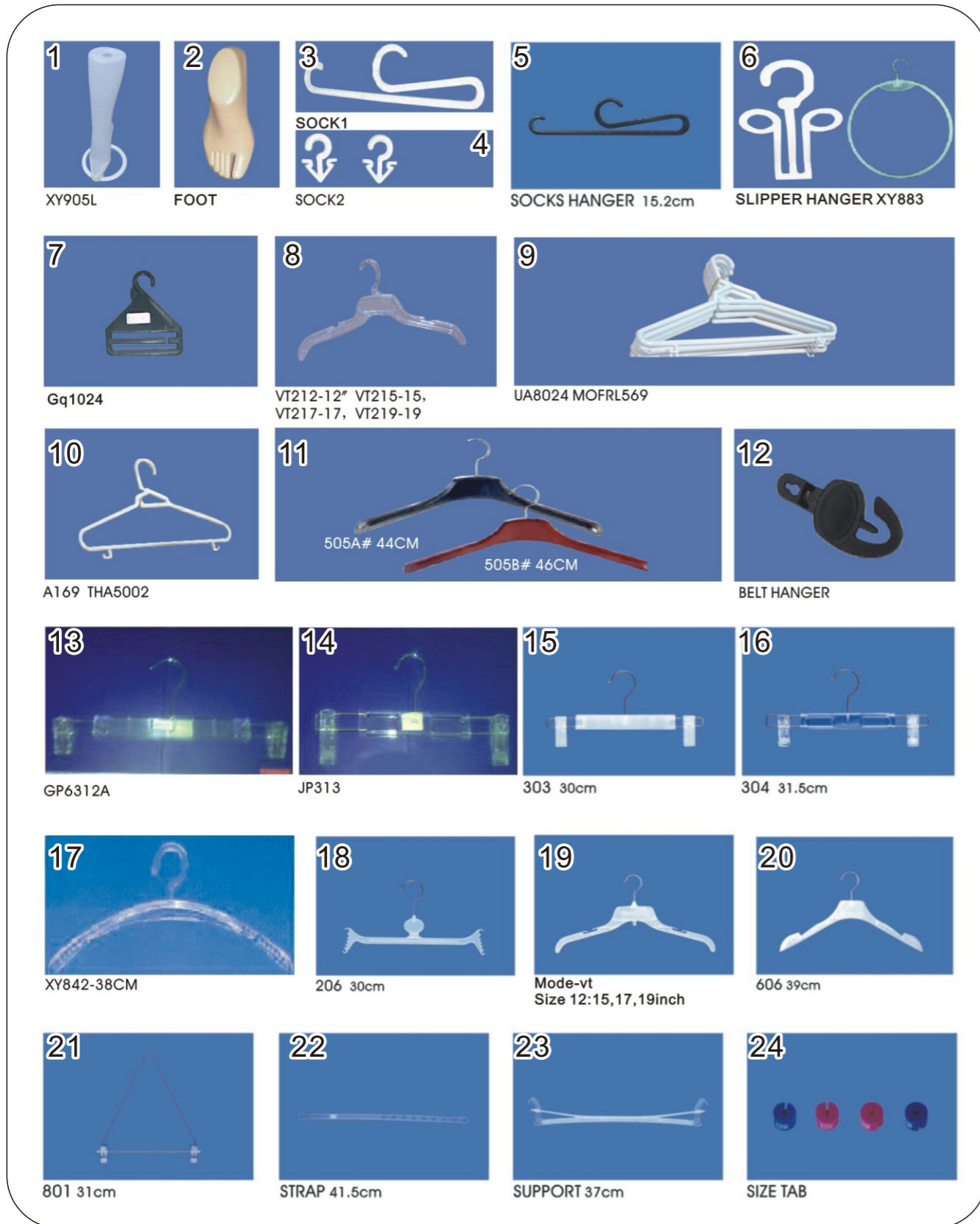

PLASTIC HANGERS

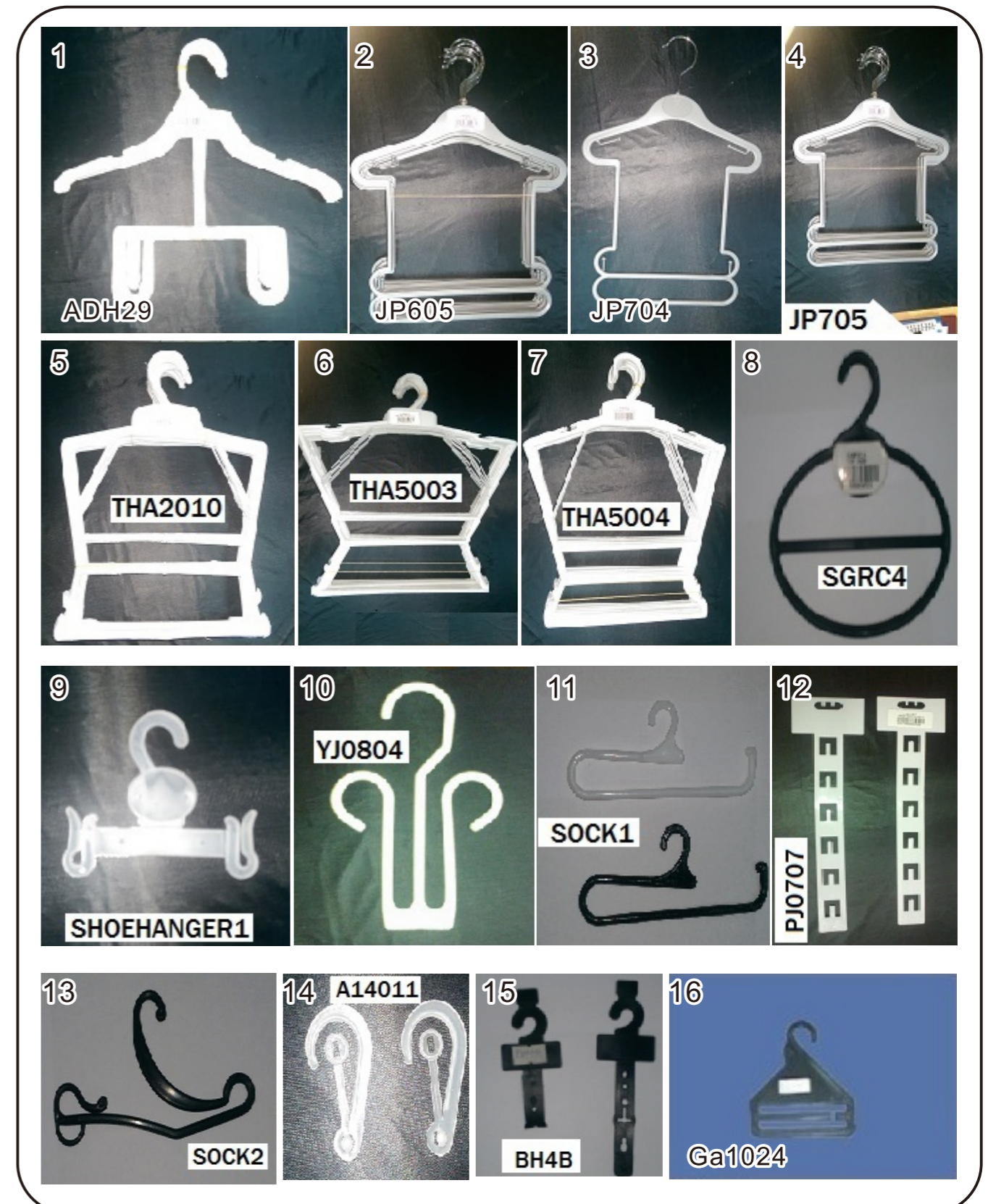



HANGER

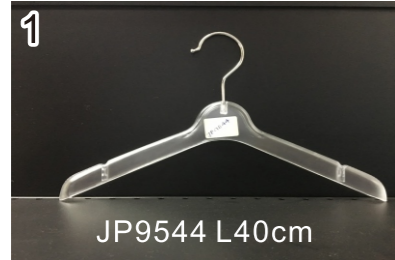

JP9544 L40cm

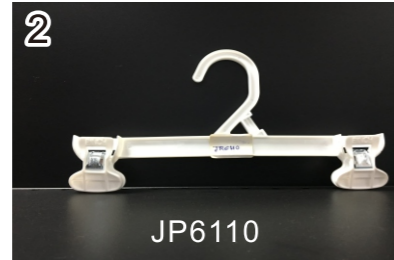

JP6110



JP625B L47cm



JP632B L37.5cm

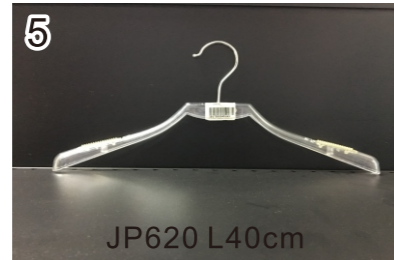

JP620 L40cm



JP632B L37.5cm



JP382B L38cm



JP705



JP633 L39CM

WOODEN CASK



WC02H40CM



WCD40XH24



WCOVER



BREAD RATTAN BASKET



Holder 673127 485*300mm
Basket 673125B-RO Φ265*65mm



Holder 673128 485*485*50mm
Basket 673125B-RO Φ265*65mm



Holder 671355 535*650*525mm
Basket 671325B-RE 535*300*100mm
PC Cover CS900001



674076-OT
Φ280*H580mm



674507C
230*230*290*H475mm



674508B
Φ330*215*H390mm



674509B
410*295*160*H390mm



Holder 673129 360*485mm
Basket 673124B-RO Φ200*65mm



674077-OT
500*380*H180/95mm

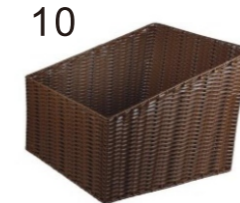

674065-OT
580*550*280*H430mm



674064-OT
580*550*160*H320mm



671003B-RE
530*315*H90mm



671040-RE 370*260*H70mm
671041-RE 400*285*H70mm
671042-RE 460*340*H70mm



671045-RE 370*245*H40mm
671046-RE 385*280*H40mm
671047-RE 415*300*H40mm



Basket 671003-RE 530*315*H90mm
PC Cover CS90001



PLASTIC MANNEQUINES



NOTES

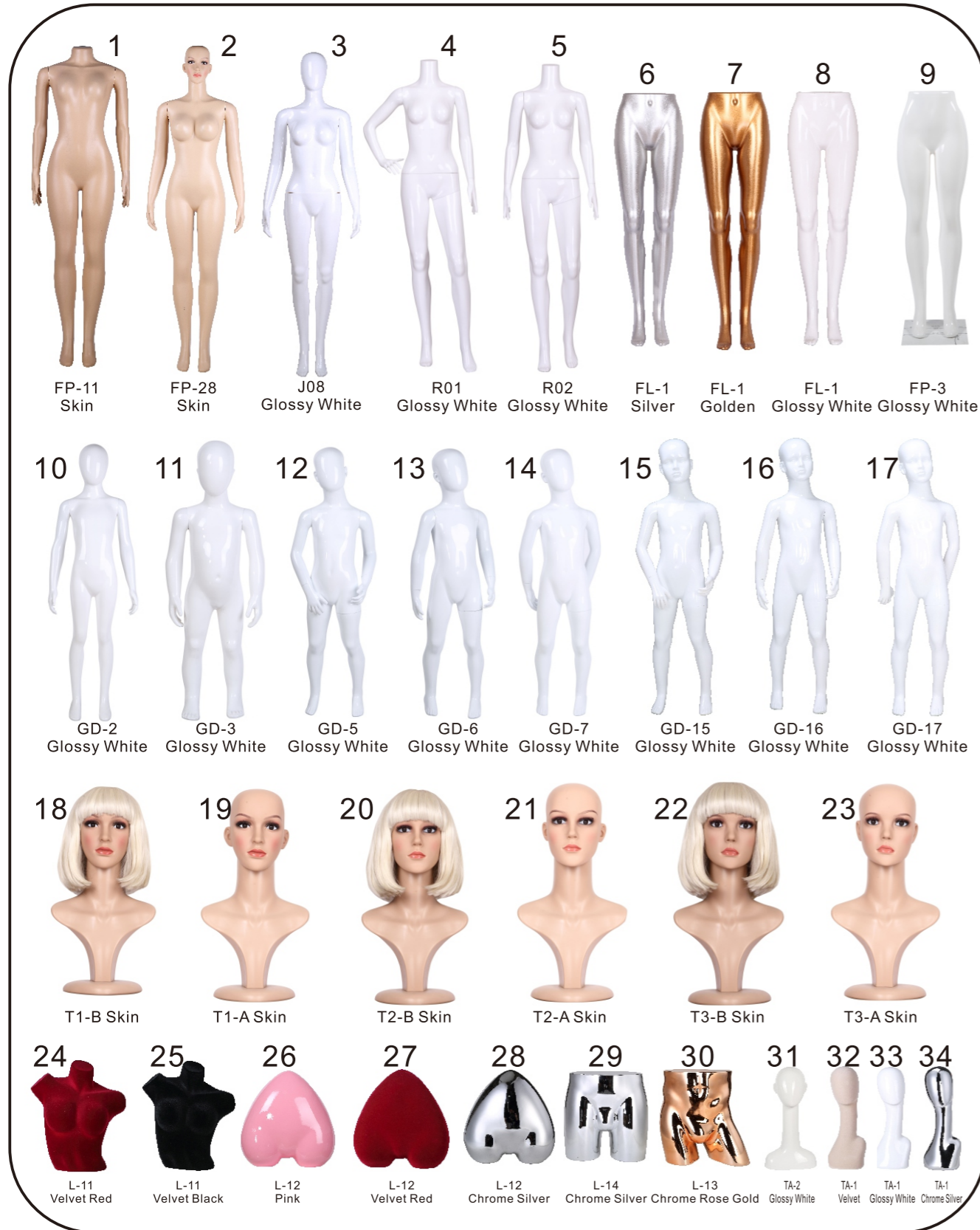

Notes section with horizontal dotted lines for writing.